



SALES CATALOG



DRAPE, HARDWARE, ACCESSORIES, CARPET & MORE



Drape Kings drape panels are made to the highest standards utilizing only the finest quality IFR fabrics in a large variety of colors and styles. They are sewn with reinforced box stitches and constructed with an attention to detail that ensures a durable and long lasting product.

OUR DRAPE PANELS OFFER

- Top finish options are pipe pockets, thru ties, blind ties, or Velcro
- The original Pipe and Drape Velcro tear back pocket
- 1"-2" (2.5-5cm) side hems typical (except sheer)
- Optional bottom hem, pipe pockets or weights, grommets
- Standard and custom sizes available
- Machine washable, minimal shrinkage, maintains shape & size (except sheer)

CALL FOR PRICING

Fabric also sold by the yard



King Chocolate



Grey

ENCORE IFR 22OZ / 15OZ

- Brushed pile fabric with superb draping quality
- Heavyweight polyester
- 22oz is 64" (163cm) wide / 15oz is 62" (157cm) wide
- Durable and machine washable
- Higher strength, more tear resistant than cotton
- Higher rub test results than cotton
- Suited for high humidity and outdoor venues
- Noise and sound reduction



Cashmere

KING IFR VELOUR 14OZ

- Beautiful fabric with premium draping quality
- Rich long nap polyester
- Opaque with high light opacity
- 54" (137cm) wide
- Durable and machine washable
- Higher strength, more tear resistant than cotton
- Higher rub test results than cotton



Red

SUPERVEL IFR 8OZ

- Lightweight polyester fabric with excellent draping quality
- Economical alternative to heavier fabrics
- 60" (152cm) wide
- Durable and machine washable
- Higher rub test results than cotton

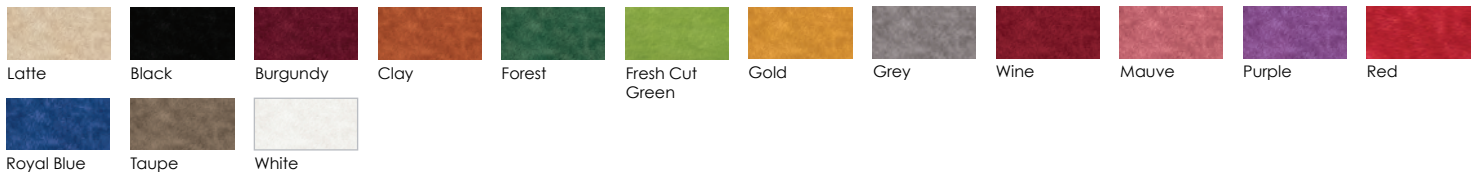

Note: Fabric dye lots vary. Samples will be provided upon request.



Natural



MUSLIN IFR 40Z

- Lightly woven cotton-like polyester
- Medium weight
- 120" (305cm) wide
- Great for lighting effects both front and back
- Durable and machine washable

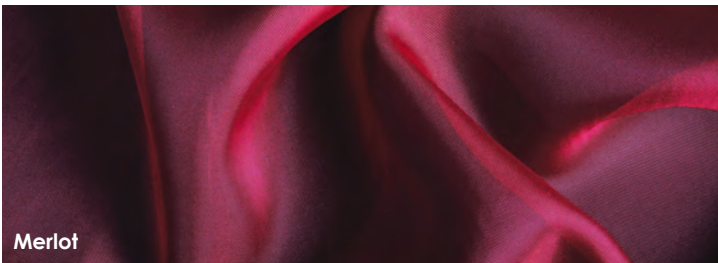

Merlot

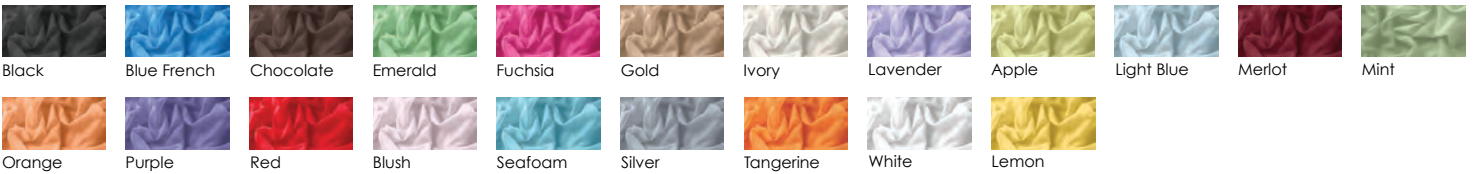

SHEER IFR 20Z

- Elegant sheer polyester
- Lightweight with cloudy transparency
- Use alone or as an overlay
- Great for lighting effects
- 120" (305cm) wide
- Additional colors available upon request
- Durable and machine washable



Silver



CRUSH IFR 2.50Z

- Lightweight, shimmery polyester with natural crinkles
- Ideal for use as decorative treatment
- Works well with special event lighting effects
- 112" (285cm) wide
- Durable and machine washable

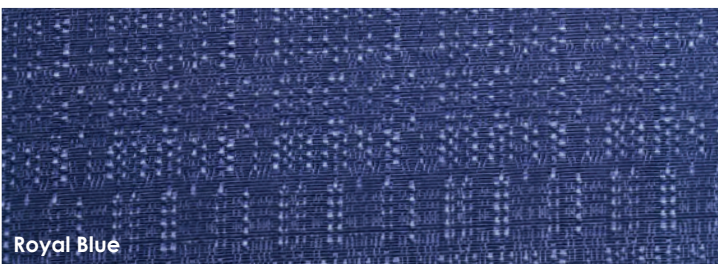

Royal Blue



BANJO IFR 70Z

- Economical drape, typically used for trade show booths and displays
- Medium weight
- 48" (122cm) wide
- Durable and machine washable

Note: Fabric dye lots vary. Samples will be provided upon request.

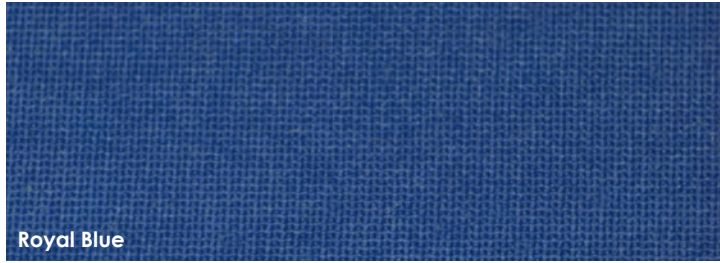

POLY PREMIER IFR 50Z

- The upscale alternative to Banjo drape
- 100% polyester
- Great for backdrops, weddings, meeting rooms, offices & schools
- 125" (318cm) wide
- Durable and machine washable
- Additional colors available upon request

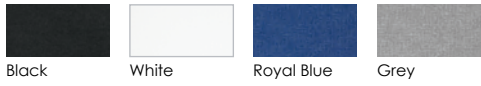

CHINA BLACK IFR 80Z

- Opaque matte satin with 99% light opacity
- Great for black out drape
- 59" (152cm) wide
- Durable and machine washable



DUVETYNE FR 80Z

- 100% cotton with a brushed matte finish
- Great for masking
- 54" (137cm) wide
- Can be made into economy drape
- Durable and machine washable

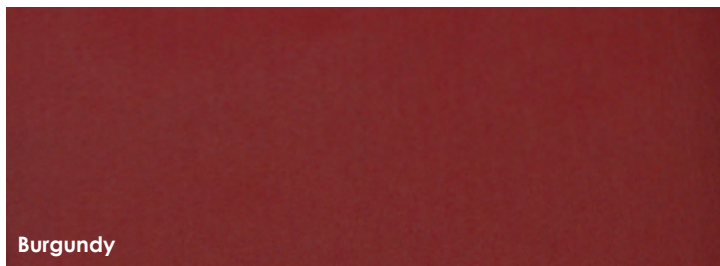

TAFFETA 40Z (PLASTIC)

- Can be wiped down with a moist cloth without damaging the integrity of the material
- Made of virgin HPDE vinyl film
- 54" (137cm) wide
- CA Flame Certification Section 13115
- 100% recyclable



See our event carpet on pg. 19

Note: Fabric dye lots vary. Samples will be provided upon request.

Our custom fabrication projects extend from one-of-a-kind creations curated for a single event to robust products designed and built for years of usage. They include Austrians, Canopies, Ceiling Treatments, Permanent and temporary Track, Film & TV set décor, Contract Services, Fabric & PVC Projection Screens, Swags & Jabots and Custom Hardware. We can build a project from a simple napkin sketch or a detailed CAD drawing or somewhere in between!

Our custom fabrication department will skillfully and swiftly execute your drape design. Tell us what you need and when you need it by. One of our fabrication specialists will be delighted to work with you!

THEATRICAL & EVENT

When it comes pipe and drape for special events, our expertise is without question second to none. Our manufacturing team has designed, built and supplied our own rental collection as well as created stock drape for countless event companies around the world. With innovations such as the "Original Tear Back Pipe Pocket," we reinvented the marketplace.

The special event market is built on the basics of theatre and drama. We are fully at home in the production of everything for the stage and studio, including: valances, front curtains, backdrops, side curtains, borders, legs, mid stage travelers, scrim, rear curtains, cycloramas, and worldclass digital backdrops.



Custom White Superval Projection Screens; Gotham Hall, NYC



Window Treatment Dolce & Gabbana; Madison Ave. NYC



Drape Kings fabrication team



Luxurious 22oz IFR Burgundy Encore

CONTRACT SERVICES

We offer a full range of contract services for showroom, retail, hospitality, offices, restaurants, education and any number of facilities. From concept to fabrication through on-site installation, we can offer everything from start to finish, as well as a la carte services.

THE WORKROOM

Our designers work tirelessly in concert to create everything from stock sized pipe and drape panels to the most unique and complex custom creations. With very few limitations, our workroom can produce everything from a single drape panel to an intricately suspended track layout.

FABRIC OPTIONS

Our ever growing library of materials and suppliers allows us to put everything together for your next project. In most cases we can also work with customer supplied fabrics. If we can't find your color, many of our mills offer custom Pantone dyeing (minimums may apply) to get a perfect match.

INSTALLATION SERVICES

Whether it's a small window treatment or an entire theatre, our expert staff of welders, metal fabricators, carpenters and installation technicians will get the project done on time and on budget. Our vast experience allows us to install onto almost any surface including concrete, metal, plaster and wood. If it can be done, we'll make it happen!

CALL FOR PRICING



Crushed Gold Bullion Drape; Barneys NY. Photo by BFA, Courtesy of Barneys NY.



THE BASICS

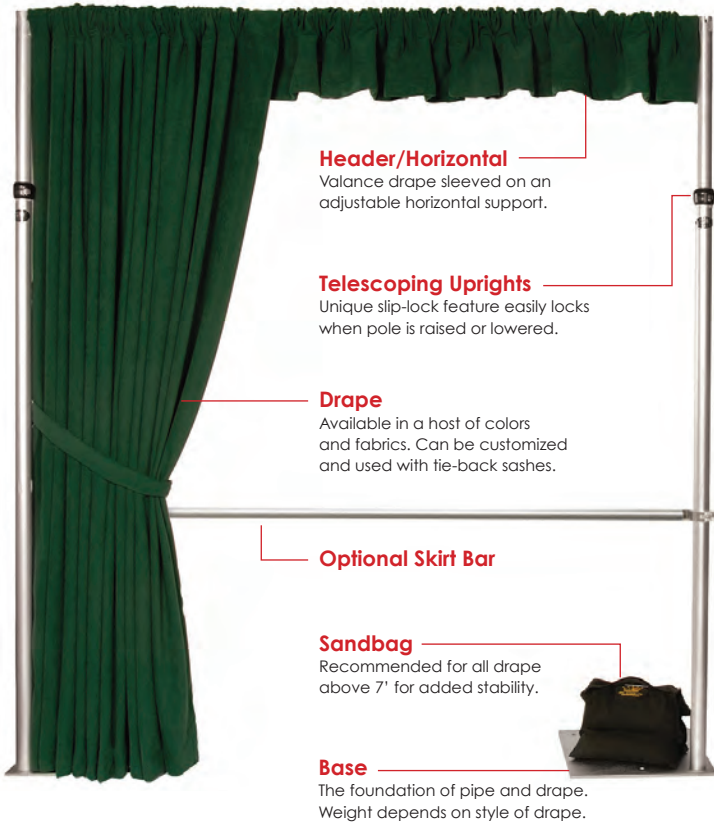

Everything starts with a good foundation. Pipe and drape begins with 6lb - 62lb bases, as required by the height and weight of the drape. If necessary, sandbags may be added for further safety and stability.

Next, we offer a selection of telescoping adjustable uprights that range from 2' to 24' high. Standard, non-adjustable uprights are also offered for trade show booths and knee-walls.

Every room is different, and that's why we offer a complete selection of adjustable horizontal drape supports ranging from 2' to 16'. These are chosen based on your needs and the weight of the drape to be supported.

FULLNESS

A gathering technique in which the drape is sewn or gathered with more fabric than the width of coverage. Fullness gives a richer look to the drape, breaking the plane of a flat curtain and allowing for more depth of field and light absorption.



Flat
Allowing the drape to lay without gathering or folding.



50% Fullness
Drape with a 1:1.5 ratio. 50' span would be covered with 75' of drape. Allows for gathering of drape to create a rich appearance.



100% Fullness
Drape with a 1:2 ratio. 50' span would be covered with 100' of drape. Allows for deep pleats and a thick, regal display.

FABRIC FINISHES



Original Tear Back Velcro Pocket
An overlapping of drape via a Velcro pocket. Allows for a seamless transition from one pipe fixture to another.
***Standard with all drape orders**



Ripplefold® Curtain
A flat drape with snaps in its top finish allowing for varying fullness. Recommended for lighter weight drapes.

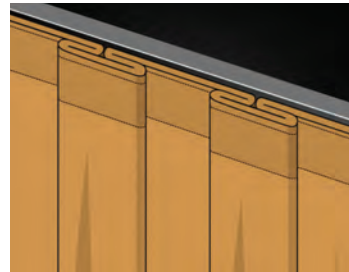

Box Pleats
The double pleating of drape in which the two outer folds face the opposite direction and the two inner folds face each other.

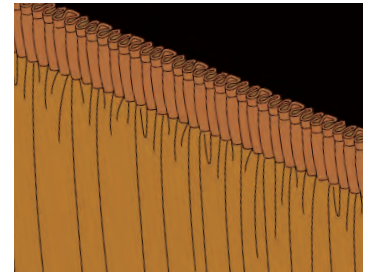

Shirring
Consists of two or more rows of gathered fabric using elastic thread in parallel rows. Shirring is used with a top treatment of hook and loop webbing.

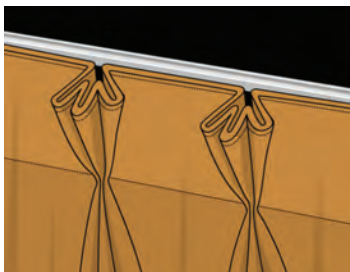

Pinch Pleats
Provides a formal yet elegant gathering for our medium to high weight fabric at 100% fullness.

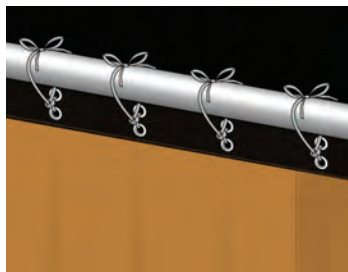

Blind Ties
A simple, looping tie system where the drape is hung immediately below the pipe with the cord looped through two grommets in the top finish.



Standard Grommets
A traditional hanging system in which ties are slipped through a reinforced, metal grommet.



Snap Hooks
A simple, smooth and sturdy hanging method traditionally used with Traveler Track.



AUSTRIAN

Richly pleated Austrian curtains create drama and glamour for a timeless look. These specialty curtain treatments are available in a variety of fabrics. Modular widths and heights create an array of effects from a simple straight raise to multiple scallops. Austrians are available as valances as well as full stage curtains.



TIEBACKS

- Available in many color options (pg 2)
- Open-ended with Velcro tabs

CALL FOR PRICING

Part #	Price
S-DKTIE	\$10.00

SWAGS



Swag is a decorative fabric treatment featuring a series of cascading curves or a single cascading curve. They may be used alone or can be paired with drapes to add a touch of formality and elegance.

SWAG-TO-GO™



- Pre-draped double-sided Swag drape bar
- Creates the same visual effect from either side
- 7' width x 3' height, double-sided shown

CALL FOR COLORS AND SIZES

CALL FOR COLORS AND SIZES

SHOWLED™ STAR DRAPE

STANDARD AND CUSTOM SIZES AVAILABLE **CALL FOR PRICING**

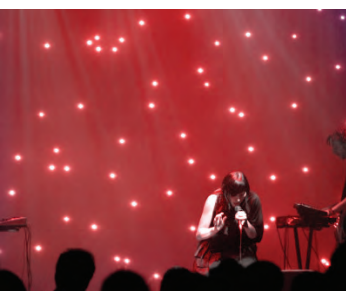

CLASSIC

Uses bluish-white LED lights. LEDs are placed in the black Encore fabric, forming constellations and star fields, divided over eight DMX channels. The controller can also be programmed manually and the settings can be saved.



CHAMELEON

Offers the same features and easy programming options as ShowLED Classic, but in any given color. By following the menu structure on the LCD display, the controller can be programmed to offer color changes, twinkling effects, chases, and more.

Uprights are available in a few different variations: **non-adjustable**, **telescoping** and upgraded to **Pipe & Base 2.0**. You should make your selection based on your needs and the weight of the drape to be supported. Non-adjustable uprights are the economical option and are typically used for trade show booths and knee-walls. Telescoping uprights are easy to set up and automatically lock to your desired height. Our upgraded Pipe & Base 2.0 version comes fitted with Versatop crowns for added flexibility. Our adjustable horizontals can also be upgraded to Pipe & Base 2.0.

UPRIGHTS

- Non-adjustable heights of 3' and 8' and split versions for shipping (S-TS 35-SB is adjustable. Split version shown at right)
- Each equipped with four slots positioned every 90°
- 8' height has additional slots at 3' high
- A chrome end cap comes standard on all 3' uprights
- 1 1/2" outside diameter

Part #	Height (ft)	Height (m)	Price	P&B 2.0
S-315	3'	.91	\$8.50	\$14.35
S-615	6'	1.83	\$15.00	\$25.00
S-815	8'	2.44	\$18.00	\$33.00
S-815-2	8' (splits in 2)	2.44	\$25.00	\$39.00
S-1915	19"	.48	\$5.51	\$15.00
S-1015	10'	3.04	\$34.00	\$40.90
S-TS 35-SB*	3'-5'	.91-1.5	\$40.00	\$55.00



Standard Split (2-piece)

*S-TS 35-SB adjustable upright with snap button. Special request only.

THE 4 TOPS



STANDARD



GOOD



BETTER



P & B 2.0

TELESCOPING UPRIGHTS

- Easy to set up and adjust without tools
- Unique slip-lock collar locks automatically when inner pole is raised or lowered
- Two-piece top pole has 2" outside diameter
- Three-piece top pole has 1 5/8" outside diameter



TWO-PIECE UPRIGHTS

Part #	Height (ft)	Height (m)	Standard	Good	Better	P&B 2.0
S-TS 35	3'-5'	.91-1.5	\$53.25	\$69.25	\$73.25	\$69.00
S-TS 47	4'-7'	1.2-2.1	\$60.00	\$76.00	\$80.00	\$79.00
S-TS 58	5'-8'	1.5-2.4	\$63.00	\$79.00	\$83.00	\$82.00
S-TS 610	6'-10'	1.8-3.0	\$70.00	\$86.00	\$90.00	\$94.00
S-TS 712	7'-12'	2.1-3.6	\$72.00	\$88.00	\$92.00	\$99.00
S-TS 814	8'-14'	2.4-4.2	\$74.70	\$90.70	\$94.70	\$111.00
S-TS 916	9'-16'	2.7-4.8	\$79.15	\$95.15	\$99.15	\$120.00
S-TS 1222	12'-22'	3.6-6.7	\$109.00	\$125.00	\$129.00	\$140.00
S-TS 1426	14'-26'	4.2-7.9	\$121.35	\$137.35	\$141.35	\$162.00

THREE-PIECE UPRIGHTS

Part #	Height (ft)	Height (m)	Standard	Better	P&B 2.0
S-TS 551	5'-11'	1.52-3.35	\$127.00	\$143.00	\$144.61
S-TS 614	6'-14'	1.83-4.27	\$137.60	\$153.00	\$152.43
S-TS 717	7'-17'	2.1-5.1	\$148.00	\$164.00	\$165.00
S-TS 820	8'-20'	2.44-6.1	\$158.00	\$174.00	\$158.96
S-TS 923	9'-23'	2.7-7.0	\$169.00	\$185.00	\$186.00

See our storage options on pg. 17



HORIZONTALS

- High-strength aluminum
- Heavy-gauge zinc-plated steel hook
- Can be used at any length between fully collapsed and maximum stop
- Collapsed length of 5' or longer can extend one foot over maximum stop
- Minimal snagging of drape during installation and removal

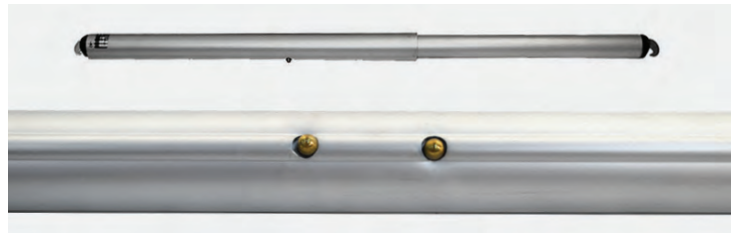

Standard on top. Detail of the split on bottom.

Part #	Width (ft)	Width (m)	Price	P&B 2.0
S-TDS 23	2'-3'	.61-.91	\$14.00	\$25.00
S-TDS 35	3'-5'	.91-1.5	\$17.95	\$29.00
S-TDS 47	4'-7'	1.2-2.1	\$21.83	\$33.00
S-TDS 58	5'-8'	1.5-2.4	\$25.97	\$39.00
S-TDS 681	6'-10'	1.8-3.0	\$28.99	\$41.00
S-TDS 712	7'-12'	2.1-3.6	\$32.88	\$45.00

Part #	Width (ft)	Width (m)	Price	P&B 2.0
S-TDS 8024	8'-14'	2.4-4.2	\$38.56	\$50.00
S-TDS 9246	9'-16'	2.7-4.8	\$42.86	\$54.00
S-TDS 81*	8'-10'	2.4-3.0	\$41.00	\$59.00
S-DB 10	10"	.25	\$6.00	\$18.00
S-DB 14	14"	.36	\$8.00	\$19.00
S-DB 19	19"	.48	\$10.00	\$21.00

*S-TDS 81: Special three-piece 8'-10' adjustable support that breaks down to 4' lengths

PIN & SCREW ASSEMBLIES



For use with standard & telescoping uprights

Part #	Size (in)	Size (cm)	Price
S-110009	1.5" x 3.5"	3.8 x 8.9	\$8.00
S-110048	1.5" x 6"	3.8 x 15.2	\$11.10
S-110010	2" x 4"	5.1 x 10.2	\$7.70
S-110011	2" x 6"	5.1 x 15.2	\$9.50
S-110012	2" x 8"	5.1 x 20.3	\$10.00
S-110095	2" x 16"	5.1 x 40.6	\$25.30

REPLACEMENT END PLUG ASSEMBLIES



Replaces damaged end of horizontal support. Assembly includes end plug, hook and rivet. Use one small and one large for each crossbar

Part #	Size	Price
S-110003	Large	\$3.50
S-110004	Small	\$3.50

RUBBER WEIGHTS

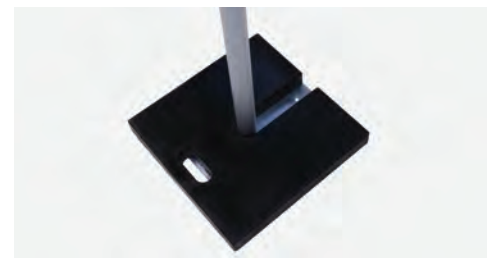

Made of recycled rubber and designed to slip easily over an upright and base. Convenient carrying handle and stackable.

Part #	S-RB18-30LB
Dimensions (in)	18" x 18" x 2"
Dimensions (cm)	46 x 46 x 5
Weight (lbs)	30lbs
Weight (kg)	13.6
Price	\$30.39

SANDBAGS



2 Saddle Sandbags are available pre-filled or empty with double zippers for increased durability. Made of heavy Denier Cordura fabric, these water repellent sandbags are resistant to abrasion, rot and mildew. Top and bottom handles make for easy carrying and double cross hatched stitching gives extra reinforcement. The 4 Saddle Sandbags disperse weight over a wider area of base plates for greater stability.

Part #	Weight (lbs)	Weight (kg)	Price
S-SB25-2S-SAND	25 (sand)	11.34 (sand)	\$35.00
S-SB25-2S-NOSAND	Zippered for easy filling (no sand included)		\$30.00
S-SB25-4S-SAND	25 (sand)	11.34 (sand)	\$45.00

See our storage options on pg. 17



BASE ASSEMBLIES

Bases are offered in various sizes and weight, and are selected based on the weight and heights of the drapes to be hung. Assemblies all include the baseplate, choice of pin, and screw. Our low profile design minimizes obstruction to guests and includes zinc-plating for rust protection and long term use.



STANDARD 3 HOLE BASE

- Three holes (extra pin holes at additional cost)
- Available in 17lb or 35lb models
- Use with basebox S-BB835 on pg. 17

8 HOLE BASE

- New 35lb base
- Easy grip handle, rounded corners
- Eight holes for more versatility
- Use with basebox S-BB635 on pg. 17

8 HOLE BLACK BASE

- New 35lb **powder coated** base
- Easy grip handle, rounded corners
- Eight holes for more versatility
- Use with basebox S-BB635 on pg. 17

9 HOLE BASE

- New 35lb base
- Nine holes for more versatility
- Use with basebox S-BB835 on pg. 17

BASE COVERS

- Drape Kings exclusive shower cap design offers easy installation once base is in place
- FR poly-spandex material with reinforced edges for durability
- Flexibility allows for off-set pins and sandbags
- Has ability to mask sandbags
- Available in black, white or custom

Part #	Price
S-BASECOVERBLACK-18	\$22.00
S-BASECOVERWHITE-18	\$22.00
S-BASECOVERBLACK-24	\$27.00
S-BASECOVERBLACK-24	\$27.00

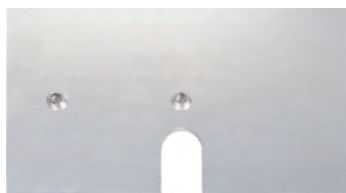

LIGHTWEIGHT BASE

- Comes with two pin holes and a stacking slot
- Available in 6lb or 12lb models



X-BASE

- Lightweight, portable base
- Fold down for easy storage and transport
- Ideal for Tech Surrounds

See our base boxes on pg. 17

Part #	Length (in)	Length (mm)	Width (in)	Width (mm)	Thick-ness (in)	Thick-ness (mm)	Weight (lbs)	Weight (kg)	Pin Size	Compatible Upright	Recommend-ed Drape Height	Price
S-B 814	8"	203	14"	355	3/16"	9.5	6lbs	2.7	1.5"	1.5" standard	3'	\$13.50
S-B 1416	14"	355	16"	406	3/16"	9.5	12lbs	5.4	1.5"	8' standard	8' Banjo/Poly	\$20.00
S-B 1818	18"	457	18"	457	3/16"	9.5	17.5lbs	7.9	2" x 4"	up to 8'	8' Velour	\$39.99
S-B 181838	18"	457	18"	457	3/8"	19	35lbs	15.8	2" x 6" or 8"	up to 16'	16' Velour	\$65.00
S-B 181838 8	18"	457	18"	457	3/8"	19	35lbs	15.8	2" x 6" or 8"	up to 16'	16' Velour	\$79.00
S-B 181838-8BK	18"	457	18"	457	3/8"	19	35lbs	15.8	2" x 6" or 8"	up to 16'	16' Velour	\$96.00
S-B 181838-9	18"	457	18"	457	3/8"	XX	35lbs	15.8	2" x 6" or 8"	up to 16'	16' Velour	\$79.00
S-B 2424	24"	609	24"	609	3/16"	9.5	31.5lbs	14.3	2" x 6" or 8"	up to 16'	16' Velour	\$65.00
S-B 242438	24"	609	24"	609	3/8"	19	62lbs	28.1	2" x 6" or 16"	up to 22'	22' Velour	\$151.00
S-XBASE	17.5"	444	15.4"	390	1/8"	6	4lbs	1.8	3/2" or 4"	up to 8'	5'	\$24.00

Note: Sandbags are always recommended to counter balance the drape weight and improve stability. All Pipe and Bases are available with black powder coating - call for pricing.

RETROFIT PRODUCTS

Drape Kings Pipe & Base 2.0 makes event setup a snap with quick and easy installation. It can be used with existing hardware, making the upgrade process cost effective. Legacy systems are prone to slot damage and limited flexibility. A new solution has been LONG overdue!



2 STAGE CROWN

Offers amazing flexibility. Includes precisely tapered sockets to support cross bars outfitted with Ball Caps.

Part #	Size (in)	Price
S-VTCROWN2	2"	\$15.00



3 STAGE CROWN

Available for the most popular upright sizes in the market. This makes the conversion of your inventory one of the easiest upgrades ever.

Part #	Size (in)	Price
S-VTCROWN3	2"	\$15.00



DECO CROWN

The Deco Crown offers more than meets the eye. It's built to withstand the most abusive environments and will give you years of use.

Part #	Size (in)	Price
S-VTCROWN15	1.5"	\$10.00

BALL CAPS (SM + LG)

Allows full range of motion for crossbars and provides major time savings during set up.



Part #	Size	Price
S-VTREPL-END-S	Small	\$10.00
S-VTREPL-END-L	Large	\$10.00

PIPE & BASE 2.0 ACCESSORY KIT

Includes: (4) Sidearms, (4) Angle Mounted Crowns, (1) Steel Mounting Post, (1) Threaded Ball Stud, (1) Socket Clip, and (4) 360 clamps.



Part #	Price
S-DK2.0KIT	\$451.65

ACCESSORIES AND ATTACHMENTS



THE SIDEARM

The Sidearm is the best solution to safely and easily install multiple drape lines to a single upright.

Part #	Size (in)	Price
S-240970-VT	1.75" x 3.75"	\$24.99



SHOULDER MOUNT

Allows users to add a wide variety of lightweight accessories to drape lines, from curtain swags to exit signs.

Part #	Size (in)	Price
S-340980-VT	1.625" x 2"	\$19.99



ANGLE MOUNTED CROWN

One of the most versatile tools in our product line. With pre-drilled holes for attachment, it gives users many options when setting up.

(Required 360 Clamp sold separately)

Part #	Size (in)	Price
S-950050-VT	1.8" x 2.5"	\$29.99



SOCKET CLIP

A simple solution for integrating old slotted uprights with your upgraded Pipe & Base 2.0 system. A "must have."

Part #	Size (in)	Price
S-100006-10-VT	.75" x 2"	\$33.00



THREADED BALL STUD

One of the most useful accessories in the lineup. Connect a variety of elements to the 2.0 system, including screens, flats, signs & more.

Part #	Size (in)	Price
S-010001-10-VT	.5" x 2.05"	\$59.99/pk of 10



STEEL MOUNTING POST

Mount lights, speakers, cameras, and other lightweight items to the top of an upright. Eliminates the need for another stand!

Part #	Size (in)	Price
S-062004-6-VT	.625" x 2.56"	\$139/pk of 6



UPRIGHT EXTENSIONS

- Gives additional height to standard 1½", 1¾" or 2" upright
- Save on the cost of purchasing longer uprights

1½" OD STANDARD UPRIGHTS

Part #	Size (ft)	Size (m)	Price
S-220001	1'	.3	\$8.50
S-220002	2'	.61	\$12.00
S-220003	3'	.91	\$15.50
S-220004	4'	1.22	\$18.90
S-220005	5'	1.52	\$22.60

1½" OD THREE-PIECE ADJUSTABLE UPRIGHTS

Part #	Size (ft)	Size (m)	Price
S-220301	1'	.3	\$10.10
S-220302	2'	.61	\$14.40
S-220303	3'	.91	\$18.50
S-220304	4'	1.22	\$22.50
S-220305	5'	1.52	\$26.60

1¾" OD TWO-PIECE ADJUSTABLE UPRIGHTS

Part #	Size (ft)	Size (m)	Price
S-220101	1'	.3	\$9.60
S-220102	2'	.61	\$13.90
S-220103	3'	.91	\$18.00
S-220104	4'	1.22	\$22.00
S-220105	5'	1.52	\$26.10



UPRIGHT REPAIR ENDS

- Cut off damaged end and secure new one with rivet or screw (included)
- Replaces damaged ends with a 3" section and new slots
- Standard repair end has four slots, adjustable repairs ends have eight slots for versatility

Part #	Size	Upright	Price
S-110040	2" OD	2-piece	\$7.10
S-110035	1¾" OD	3-piece	\$9.20
S-110006	1½" OD	Standard	\$6.50



HEAVY-DUTY REPAIR END

- Solid extruded aluminum construction
- Built to last for years of service
- Easily replace or upgrade existing adjustable upright tops
- Top slot design allows flush drapery support hanging with no humps
- Eight way slot design offers more opportunities for hanging drapery in multiple directions

Part #	Size	Upright	Price
S-110040-H	2" OD	2-piece	\$12.00



STANCHION TOP WITH PIN

- Turns uprights into stanchions
- Easy slip-in installation
- Available in 1.5" and 2"

Part #	Size	Price
S-110033	1.5"	\$12.50
S-110044	2"	\$12.50



SKIRT CLAMP

**DK Patented*

- Add an additional horizontal drapery support at any height on an upright
- Create an adjustable screen surround, knee walls, or staggered ceiling solution

Part #	Price
S-DW1006	\$19.95



PIN SCREWS

- A must-have spare part; you just can't get these at any hardware store (⅜" x 1¼" flat-head screw)
- Fits all base pin sizes

Part #	Quantity	Price
S-381020	25	\$8.99
S-381050	50	\$15.99
S-381100	100	\$27.89



REPLACEMENT SPRING BUTTON

- Used for horizontal drapery supports
- Includes button plug, spring and brass button

Part #	Price
S-110021	\$3.20



TUBE EXPANDER (REPAIR PIPE)

- Used to expand damaged pipe ends
- Repair and reuse!

Part #	Size	Price
S-110084	for 1½"-1¾" diameter tube	\$49.00
S-110083	for 1⅜"-2" diameter tube	\$49.00



CURVED DRAPE SUPPORT

- Create curved or waved walls
- Requires three standard or adjustable uprights and three bases or two standard uprights, two bases and two cantilevers (sold separately)
- Curved Drape Support is not adjustable



NEW ITEM

CANTILEVERS

- Great for canopies and enclosures
- Fits on top of adjustable (2") upright
- Adjustable from 90° to 135°

Part #	Size	Price
S-110103	Single	\$25.00
S-110105	Double	\$33.00

Part #	Size (ft)	Size (m)	Price
S-301010	10' x 24"	3.04 x .61	\$99.00

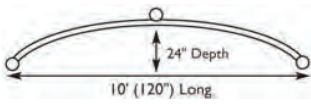

COLUMN / CIRCLE HARDWARE

- Continue your drape around columns, obstructions or create a free-standing column of drape
- 10' circle is great for Huppas (requires four upright bases and pins)



Part #	Size (ft)	Size (m)	Price
S-301033	3' diameter curved horizontals	0.91	\$131.00/pair
S-301034	4' diameter curved horizontals	1.22	\$141.00/pair
S-301035	5' diameter curved horizontals	1.52	\$151.00/pair
S-301082	8' diameter circle (4 pieces)	2.44	\$171.00/set
S-301080	10' diameter circle (4 pieces)	3.05	\$181.00/set



KING COLUMN

- Complete decorative accent for your event
- Custom two-piece hoop that only requires one upright for quick and convenient setup
- Includes 35lb baseplate and pin, 7'-12' upright, 2 four-saddle sandbags and 90' of sheer drape

Part #	Height (ft)	Height (m)	Price
S-DKCLM8	8'	2.44	\$650.00
S-DKCLM10	10'	3.05	\$675.00
S-DKCLM12	12'	3.66	\$725.00
S-DKCLM	30" diam	.76 diam	\$161.00

QUICK-TRACK

- The speed of pipe & drape with the benefits of track
- Perfect for creating doorways within a drape wall
- Attaches to standard and adjustable uprights
- Carriers sold separately



Part #	Length (ft)	Length (m)	Price
S-QT 130-6	6'	1.82	\$68.00
S-QT 130-8	8'	2.43	\$89.00
Curtain carriers	-	-	\$14.37 ea
Curtain clips	-	-	\$2.25 ea

CURTAIN TRACK: 113 SERIES

- Ideal for classrooms, boardrooms, cafeterias, and multi-purpose facilities where quick partitioning is essential
- Box-shaped curtain track for straight traverses up to 20' (6.1m)
- 4lb (1.81kg) max curtain weight/ft of track

Part #	Style
S-S113 CO	Cord-operated
S-S113 WA	Walk-along nylon carriers

Note: Available in black.

CURTAIN TRACK: 140 SERIES

- Ideal for medium weight curtains on stages, TV studios and room dividers
- Versatile I-beam track for both straight and curved applications
- Overall track can reach max of 60' (18.29m)
- 7lb (3.18kg) max curtain weight/ft of track



Part #	Style
S-S140 BBWA	Cord-operated
S-S140 WA	Walk-along

CALL FOR PRICING

CALL FOR PRICING



LIGHT DUTY MINI TRUSS

- Lightweight truss for draping and light-duty applications
- F14 - 4'
- F24 - 8'

MANY SIZES AVAILABLE
CALL FOR PRICING



TRUSS HEADER

- Available in a variety of colors and fabrics
- Comes either flat or with pleated fullness
- Available with variety of top finishes for attachment to truss
- Typically 18" high

CALL FOR PRICING



TRUSS-TO-DRAPE SUPPORT ADAPTER

- Adapter tightens around standard truss pipe to hold sleeved drape on telescopic rod without the need to tie on
- Minimum two per horizontal support required

Part #	Price
S-160310	\$47.50 ea



TRUSS COVER

- Velcro closure along one side for convenience and ease of installation after truss is in place
- FR poly-spandex material
- Available in black, white or custom colors
- Sock style without Velcro available

Part #	Truss Size (in)	Truss Size (mm)	Price
S-TRUSS12W-Velcro	12"	290	\$14.00/ft
S-TRUSS12W-Tube	12"	290	\$9.00/ft
S-TRUSS12B-Velcro	12"	290	\$140.00/ft
S-TRUSS12B-Tube	12"	290	\$9.00/ft
S-TRUSS20W-Velcro	20"	520	\$18.00/ft
S-TRUSS20W-Tube	20"	520	\$13.00/ft
S-TRUSS20B-Velcro	20"	520	\$18.00/ft
S-TRUSS20B-Tube	20"	520	\$13.00/ft

**Custom sizes available*

CUSTOM COVER SOLUTIONS

- FR custom fabric covers made for tripods, speaker stands, flat panel displays, or just about anything
- Closure options include Velcro, zipper, or sleeve
- Each sock custom built to your dimensions
- Available in black, white or custom colors



CALL FOR PRICING

PIPE SOCKS

- FR poly-spandex sleeves to hide uprights
- Flexible in terms of pipe position
- Easily adjustable to various heights
- Available in black, white or custom colors

Part #	Price
S-PS-BLACK	\$2.00/ft
S-PS-WHITE	\$2.00/ft



CUSTOM COLOR DYE LOTS AVAILABLE:
MINIMUMS APPLY
CALL FOR DETAILS



CROSSBAR HANGER

- Easily add lighting, signage or a canopy with no additional uprights
- Minimum two required, sold individually



Part #	Price
S-110116	\$16.95



IN-TUBE CROSSBAR HANGER

- Allows for a second layer of drape to hang on an upright
- Works with standard and telescoping uprights
- Second layer horizontal will be slightly staggered

Part #	Price
S-110094	\$5.70



SHelf HANGER

- Add telescoping drape supports across a booth
- No additional uprights required
- Brackets easily slip over horizontal drape supports
- Minimum two required, sold individually

Part #	Price
S-110017	\$3.00



THREE-WAY IN-LINE HANGER

- Works with standard and telescoping uprights
- Allows for double fabric layers and banner hanging
- Durable black powder coat finish

Part #	Size (in)	Size (cm)	Price
S-120022	5" x 3.25"	12.7 x 8.25	\$11.00

*DK Patented

CLIP ROD SUPPORTS

- Provides additional support for a short side wall or banner
- Clips over any standard or adjustable upright
- Requires no additional hardware



Part #	Size (in)	Size (cm)	Price
S-DR 1018	10"-18"	25.4-45.7	\$12.30
S-DR 2034	20"-34"	50.8-86.4	\$16.40
S-DR 3444	34"-44"	86.4-111.8	\$21.60

VALANCE / CROSSBAR HANGER

- Add a telescoping drape support crossbar to suspend a valance, lights, or signage
- Requires one full slot in upright



Part #	Price
S-110016	\$5.00

PERMANENT INSTALL HORIZONTAL HANGER

- Mounts onto a wall for permanent installation
- Eliminates the need for bases and uprights
- Best for heavy-duty applications
- Durable black powder coat finish



Part #	Size (in)	Size (cm)	Price
S-120021	5.5" x 3.5"	13.9 x 8.9	\$17.50

*DK Patented



DOUBLE BACK WALL HANGER

- Mounts on standard uprights or 2-piece adjustable uprights
- Allows attachment of two parallel bars in any or all four directions

Part #	Size (in)	Size (cm)	Price
S-110049	1.81"	4.60	\$21.10

Minimum two required, sold individually

LIGHT TOPPER

- Allows for a lightweight bar or LED lighting unit to be attached to an upright while still using a drape horizontal

Part #	Price
S-DW-1100 (1.5")	\$14.95
S-DW-1101 (2")	\$14.95

SPECIALTY MAFER CLAMP

- Light-duty metal and plastic quick-release clamp with a removable stud and M-10 x 1.5 bolt for easy light fixture mounting
- Can be used to wrap around draped pipe
- Maximum weight 33lbs (15kg)

Part #	Price
S-DW3049	\$28.95

EXIT SIGN

- Black Thermo-plastic exit sign
- Red LED lighting
- AC powered with battery backup (batteries not included)
- Universal single / double face
- Comes with sturdy, padded case
- Available in black and white casing

Part #	Price
S-EXTSG	\$89.00

PIPE SNAP

- Clever self-loading clamp for fast mounting and relocation of drape
- Tube max diameter 2 1/4" (5.7cm)
- Complete with swiveling loop
- Available in black or white
- Load 33lbs (15kg)

Part #	Price
S-DW5001B	\$4.99
S-DW5001W	\$4.99

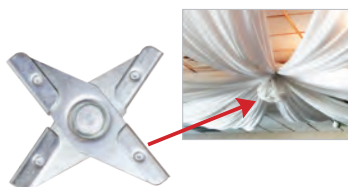
SCISSOR CLIP

- Low profile metal clip used for drop ceiling mounting
- Easily attaches to ceiling grid with 1/4" threaded stud hanging point
- Used for ceiling treatments, banners, and other fabric solutions

Part #	Price
S-SCIS-CLIP	\$5.00

PHOTOLUMINESCENT EXIT SIGN

- Glows in the dark, UL-approved & no power needed
- Does not require electricity
- Easy installation & minimal maintenance necessary

Part #	Price
S-EXTPHT	\$79.99

DRAPE CLIPS

- Allows for attachment of most fabrics
- Will not crush or tear fabric
- Use with Kabuki Drops and/or Traveler Tracks
- Sold individually

Part #	Price
S-DC-50-1	\$1.60

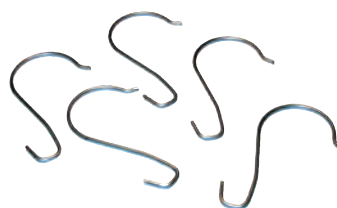
SIGN HOOKS

- Hang signs on top of crossbars or drape supports
- 3 1/2" (9cm) long
- 100 hooks per pack

Part #	Price
S-DW-110051	\$14.95

TABLE/PIN CLAMP

- Adapter attaches pin to table
- Great for mini tech or DJ Surround (see page 22)

Part #	Price
S-110069	\$18.40

HERCULES CLIPS

- For safe connection of fabric
- Will not crush or tear
- Available in black or white

Part #	Qty	Price
S-DC-50 BK	50	\$40.00
S-DC-50 WHT	50	\$40.00

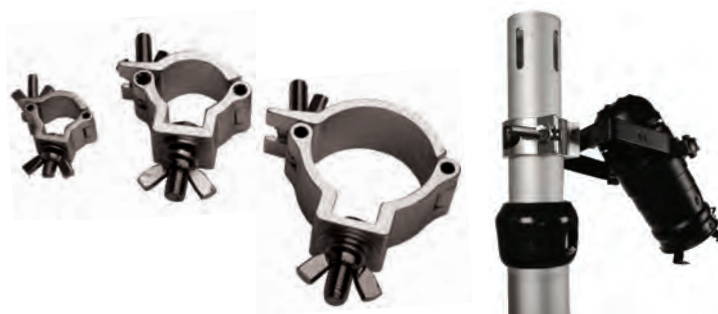
360 CLAMP

Excellent for use on drape upright or light-duty truss without causing pipe damage

Part #	Size	Pipe size (in)	Pipe size (cm)	Price
S-5003	Micro	0.55"	1.4	\$4.95
S-5036	Small	1.38"	3.5	\$6.95
S-5035	Medium	1.5"	3.8	\$7.65
S-5032	Large	2"	5.1	\$8.50
S-5032-HD	Heavy duty	2"	5.1	\$19.50



GAFFERS TAPE

- Strong, adhesive tape with clean removal
- Great for hiding electrical cords
- Colors available:

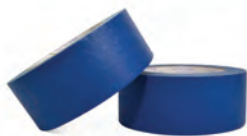

BLUE PAINTERS TAPE

- Painter's grade masking tape
- Clean release



DOUBLE-FACE TAPE

Heavy-duty tape strong enough to secure carpet to the floor even in high traffic areas

Part #	Roll Size	Price
S-TAPE2-55	2" x 55yds	\$15.25

Part #	Roll Size	Price
S-PTAPE	2" x 60yds	\$7.50

Part #	Roll Size	Price
S-DTAPE2-25	2" x 36yds	\$15.50



COVERED BASEPLATE BOX

- ATA design baseplate case with hardware compartment
- S-DKATA35P holds (18) 35lb baseplates or (36) 17lb baseplates
- S-DKATA35P-2 holds (12) 35lb baseplates with handles

Part #	Dimensions (in)	Dimensions (cm)	Price
S-DKATA35P	25.5" x 21" x 26"	65 x 53 x 66	\$950.00
S-DKATA35P-2	25.5" x 21" x 26"	65 x 53 x 66	\$950.00

HAND TRUCK

- Boasts a 500lb capacity
- Essential for moving heavy base boxes
- 10" flat-free semi-pneumatic wheels
- Made in the U.S.A.



Part #	Price
S-HT	\$139.00

STORAGE AND TRANSPORT SOLUTIONS

Whether your event is local or 3,000 miles away, storage and shipping are made easy with our solutions.

STANDARD & TELESCOPING DIVIDER DOLLY



STANDARD UPRIGHT DOLLY



ADJUSTABLE UPRIGHT DOLLY



SINGLE BASE DOLLY



CALL FOR OPTIONS

Part #	Price
S-640026	\$610.00

Part #	Price
S-640013	\$518.00

Part #	Price
S-640051	\$543.00

Part #	Price
S-640096	\$414.00

BASE BOX

- Handmade from birch plywood to store baseplates
- Slotted with heavy-duty plastic dividers for maximum safety and capacity
- Easily moved with hand truck



CUSTOM BUILT CORDURA BAG

Drape Kings makes Cordura bags for all types of product storage, whether it be for pipe and drape, audio/visual equipment, or other specific industry applications. All bags are built to your custom specifications by our fabrication department.

CALL FOR PRICING

TIE LINE

- Also known as "trick" line, #4 Tie Line is available in hanks or reels of various sizes
- Comes coated
- Available in black or natural



Part #	Fits	Price
S-BB835	(8) 35lb or (16) 17lb 18" x 18" bases	\$259.00
S-BB1416	(16) 12lb 14" x 16" bases	\$259.00
S-BB462	(4) 62lb or (8) 35lb 24" x 24" bases	\$259.00
S-BB635	(6) 35/lb bases with handles	\$259.00

Part #	Size (ft)	Size (m)	Price
S-TIE-600	600'	183	\$44.65
S-TIE-3000	3000'	914	\$143.30

*Hand truck and base box sold separately.
*Base box does not come with a logo.



Reinforced double layer



KING PIPE BAG

- Ideal for storage and transportation of pipe hardware
- Heavy, durable Cordura fabric resistant to abrasion and mildew
- Ends are reinforced with heavyweight vinyl to protect against uprights puncturing the bag
- Quick drying and highly water repellent
- Heavy-duty dual zippers
- Handles at center and both ends
- Largest bag easily holds up to four 12' to 22' uprights

Size	Dimensions (in)	Dimensions (m)	Price
S-88 BAG	88" x 8" x 8"	2.2 x .20 x .20	\$140.00
S-110 BAG	110" x 8" x 8"	2.8 x .20 x .20	\$150.00
S-144 BAG	144" x 9" x 9"	3.7 x .22 x .22	\$175.00

STANDARD CORDURA PIPE BAG

- Great for storage and transportation of pipe hardware
- Cordura fabric resistant to abrasion and mildew
- Quick drying and highly water repellent
- Heavy-duty dual zippers
- Webbed carrying handles at center of bag
- *DLX models include individual zippered compartments

Size	Dimensions (in)	Dimensions (m)	Price
S-GPA-50	50" x 10" x 5"	1.3 x .25 x .18	\$24.00
S-GPA-50DLX*	50" x 10" x 5"	1.3 x .25 x .18	\$33.00
S-GPA-58	58" x 10" x 5"	1.5 x .25 x .18	\$30.00
S-GPA-58DLX*	58" x 10" x 5"	1.5 x .25 x .18	\$34.00

BASE AND PIN BAG

- For storage and transportation of bases and pins
- Accommodates up to two baseplates (17lb)
- Cordura fabric, reinforced corners, and dual-slide zipper for durability



Part #	Dimensions (in)	Dimensions (cm)	Price
S-650005	19" x 19"	48 x 48	\$66.00

DRAPE BAG

- Ideal for storing & transporting
- Two side pockets and one front pocket for added versatility
- Heavy-duty nylon construction
- Webbed carrying handles



Part #	Dimensions (in)	Dimensions (cm)	Price
S-36BAG4	36" x 15" x 19"	91 x 40 x 40	\$49.00
S-36BAG4-WH	36" x 15" x 19"	91 x 38 x 48	\$66.79

RIGID, MOLDED PLASTIC PIPE CASE

- Drape Kings exclusively designed and manufactured
- Built-in wheels and handles for easy hauling
- Available in 8' and 10' lengths
- Holds up to 16 uprights or 20 horizontals
- Offers optimum protection



Part #	Outside Dimensions (in)	Outside Dimensions (m)	Price
S-PC-8	88" x 12" x 12"	2.2 x .3 x .3	\$349.00
S-PC-10	112" x 12" x 12"	2.8 x .3 x .3	\$395.00



MOLDED PLASTIC HAMPER

- Exclusively designed and manufactured by Drape Kings
- Rigid, molded plastic hamper designed to ship and store drape
- Keeps fabric clean, dry and protected
- 5" x 1 1/4" full-swivel casters
- Heavy-duty molded plastic lid with wheel wells for stacking
- 8 1/2" x 11" label holder on one side
- Your company logo can be added for an additional cost
- Custom colors available

Part #	Capacity	Dimensions (in)	Dimensions (m)	Price
S-16BU.3	16 Bushel	36" x 30" x 25"	.91 x .76 x .64	\$349.00

*Hamper does not come with a logo



SANDBAG STORAGE HAMPER

- Holds up to 450 lbs (204kg)
- Sturdy rope handles on sides
- Lid design allows for stacking when full
- Heavy duty 2" x 5" swivel caster wheels and painted plywood base

Part #	Capacity	Outside Dimensions (in)	Outside Dimensions (m)	Price
S-MTE-2H5	12 Bushel	37" x 25" x 25"	.94 x .64 x .64	\$312.26
S-MTE-LID	Lid for Sandbag Storage Hamper			\$36.74

CUSTOM BUILT CORDURA BAGS

Drape Kings makes Cordura bags for all types of product storage, whether it be for pipe and drape, audio/visual equipment, or other specific industry applications. All bags are built to your custom specifications by our fabrication department.

CALL FOR PRICING

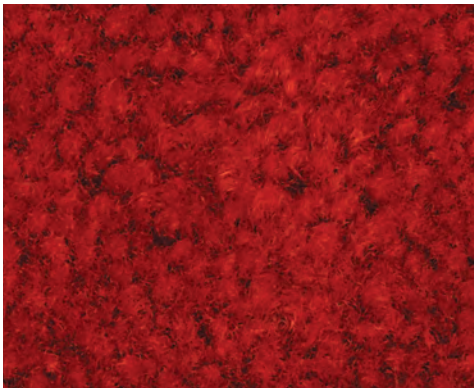

Chile Peppers



DK PRIMO SERIES

- Our most popular 16oz nylon medium pile event carpet
- Ideal for runners, rooms, or entire venues
- Available in 12' wide rolls & custom sizes
- Comes bound or unbound
- Many other colors available – call for details

CALL FOR PRICING



Super Hero



DK DESIGNER SERIES

- Vibrant, vivid colors and deep pile for an exceptional look and feel
- Available in 12' wide rolls & custom sizes
- Available in a 25.5oz deep pile and 37oz "shag" style
- 100% polyester
- Comes bound or unbound

CALL FOR PRICING



Chocolate



DK EURO SERIES

- Works great for trade show floors and large events
- Marine-backed, needle-punched 100% Olefin fiber
- Available in 12' wide rolls & custom sizes
- Can be used indoors or outdoors
- Cuts clean, eliminating need for binding

CALL FOR PRICING



Grey Stone

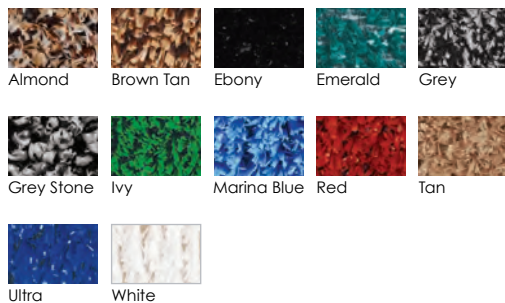

DK TURF SERIES

- Ideal for heavy traffic & outdoor spaces
- Available in 12' wide rolls & custom sizes
- Comes in Olefin or Polypropylene marine-backed styles

CALL FOR PRICING

Note: Dye lots vary. Samples will be provided upon request.



CHROME AND BRASS STANCHIONS

- Classic post and rope stanchion design
- Bright chrome or brass finish base, post and crown
- Heavy base and construction
- Removable threaded post for easy assembly
- Four-way top that accepts standard rope hooks
- Knocked-down design offers compact storage and shipping

Part #	Description	Price
S-105PC	Chrome stanchion w/ base	\$86.00
S-105PC-B	Brass stanchion w/ base	\$96.00



STANCHION ROPES

- Available in black or red and chrome or brass clips
- **Custom colors available upon request**

Part #	Length	Price
S-306BKPC - BLACK	6'	\$45.00
S-306RDPC - RED	6'	\$45.00
S-308BKPC - BLACK	8'	\$55.00
S-308RDPC - RED	8'	\$55.00

NOTE: Add \$10.00 for brass tips

KING SERIES STANCHION ROPES

- Available in black or red and chrome or brass clips
- Plush Velour
- Heavy duty firm cotton core interior
- **Custom colors available upon request**

Part #	Length	Price
S-306BKPC-KING-BLACK	6'	\$65.59
S-306RDPC-KING-RED	6'	\$65.59
S-308BKPC-KING-BLACK	8'	\$75.69
S-308RDPC-KING-RED	8'	\$75.69

NOTE: Add \$10.00 for brass tips



BLACK BELT STANCHIONS

- Streamlined modern belt stanchion design
- Black powder coated finish with plastic base cover
- Heavy base and construction
- Removable threaded post for easy assembly
- Four-way belt top that accepts standard belts in three directions with internal 10' retractable belt
- Compact storage and shipping
- Built-in threads for sign & accessory attachment
- Ideal for crowd control or blocking off areas

Part #	Description	Price
S-PCBELT	Stanchion w/ base	\$108.00

DIGITAL PRINTING

- Step and Repeat banners
- Custom designs printed on as little as a yard of fabric
- Fabricate designs on a wide variety of natural and synthetic materials with FR certification
- Start to finish solutions that you can bundle with drape fabric, event carpet, stanchions and more. Call to discuss your event needs and we'll make it happen.

CALL FOR PRICING



Bottom left photo courtesy of Big Machine Records. Photo on right by Shawn King, Pegasus Productions.



STANCHION CART

- Heavy-duty & compact, our Stanchion Cart safely stores and transports your posts and ropes
- Cart holds (11) Chrome/Brass or (8) Belt Stanchions, and (12) ropes
- Each stanchion has its own slot to avoid scratching or damage
- Separate compartment for bases & rope

CALL FOR PRICING



THE KABUKI REVEAL SYSTEM

The Kabuki Reveal is a technique (generally used in Theatre and Special Events) where a drape or other lightweight fabric is quickly dropped from the ceiling to reveal the stage/performers/product. It is a modern day special effect based on the Kabuki theatre's technique of rapid appearance of actors.

CALL FOR PRICING

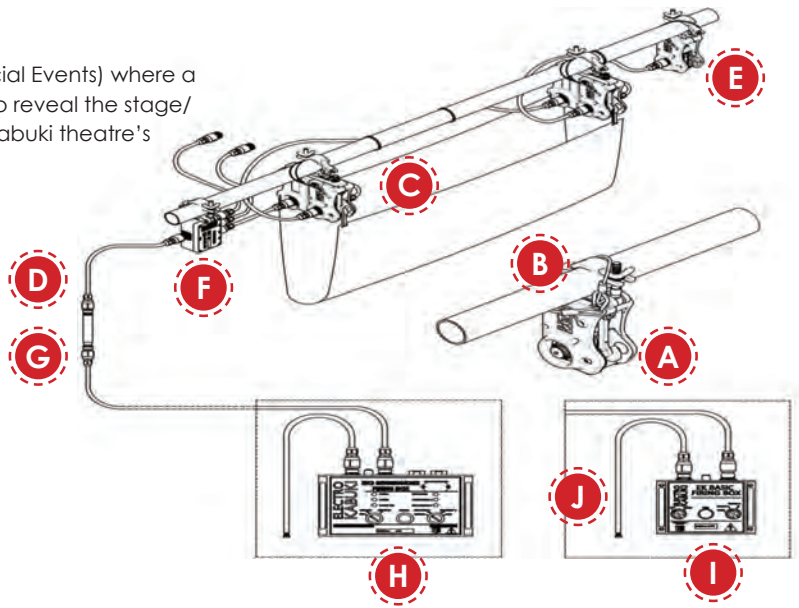

A: ELECTRO KABUKI
Supports the drape or item and releases it when signaled. Available in different voltages – 110V & 230v AC.



B: CLAMP
Heavy duty truss clamp that attaches the EK to a supporting truss or rail.



C: BACK-TO-BACK BRACKET
Supports 2 EKs on 1 clamp (for "flop and drop" releases).



D: LINK CABLE
Connects one item in the system to another. Available in different lengths.



E: END-OF LINE INDICATOR
Part of the circuitry that proves electrical continuity in the cabling. Only used with the DMX/Sensing Firing Box.



F: SPLITTER BOX
Divides the power cable into 3 branches. Helps simplify system layout and reduce amount of cable needed.



G: IN-LINE COUPLER
Connects 2 link cables to form a longer continuous length.



H: SENSING/DMX FIRING BOX
Checks the status of the system prior to firing (i.e. the position of the safety catches and continuity of the cabling circuit) and houses a push-button for local firing of the EKs.



I: BASIC FIRING BOX
Houses a push-button for local firing of the EKs and controls which EKs are fired.



J: POWER CABLE
Connects the power supply to the Firing Box. Fitted with a connector at one end and bare wires at the other.

DJ BOOTH SURROUND PACKAGE

- Quick setup table-top surround to hide your equipment and table
- 4' standard height
- Custom sizes available



KIT INCLUDES:

- Four table/pin clamps
- Four fixed uprights
- Three adjustable horizontals
- Convenient storage bag
- Supervel or King drape



Part #	Drape	Price
TTDJSPV	8oz Supervel	\$369.97
TTDJKNG	14oz King	\$445.84

*Table not included

TECH SURROUND DRAPE PACKAGE

- Discount package price for tech-surround pipe and 14oz King Velour IFR drape
- Hardware height and width is adjustable and can be set up in a variety of configurations



Part #: S-DKTECH

Qty	Description	List Price Ea.	Total
5	3'-5' adjustable telescoping up-rights	\$53.25	\$266.25
5	14" x 16" x 3/8" (12lb) baseplates	\$20.00	\$100.00
1	6'-10' adjustable horizontal cross-bar	\$28.99	\$28.99
1	5'-8' adjustable horizontal crossbar	\$25.97	\$25.97
2	4'-7' adjustable horizontal crossbar	\$21.83	\$43.66
2	King Black IFR Drape 5'H x 13'W	\$180.66	\$355.50
2	King Black IFR Drape 5'H x 9'W	\$128.20	\$252.44

(10% Discount) ~~\$1,082.59~~ Package Price: \$974.33



UNIVERSAL SCREEN SURROUND

Create a screen surround in the size you need with our patented Skirt Clamp



HOW IT WORKS:

- Start by assembling your screen, front or rear projection
- Place two uprights (baseplates and pins to the left and right of the desired masked image width) using pipe and drape hardware
- Sleeve black upright "pole-socks" over the uprights to minimize any glare or reflection from the pipe
- Sleeve the valance onto the horizontal drape support
- Install into the top slots of the two uprights
- Lock the skirt clamp onto the upright at the appropriate height for the bottom masking skirt
- Sleeve skirt onto the horizontal and install between the skirt clamps
- Adjust fullness of drape

SOFFIT SOLUTION

Adjust to varying ceiling heights without a need for additional uprights



SCREENS

- Fast-fold style
- All sizes of Draper and Da-Lite screens

CALL FOR PRICING



FABRIC SCREEN SURROUNDS

- We build custom screen surrounds to fit any screen size with the fabric of your choice
- Match your run-off drape

10' Ceiling

8' Ceiling



SCREEN HANGER ADAPTER WITH PRO-GRIP

- Adapter tightens around standard screen frames
- Adjustable cord lock hangs from truss or drape hardware
- Fully adjustable without screen legs
- Minimum two per screen required



Part #	Size (in)	Size (cm)	Price
S-160080	1.25"	3.2	\$58.90 ea
S-160050	1.38"	3.5	\$59.90 ea

TABLE SKIRTS WITH CLIPS

- FR Poly Knit or Banjo cloth, with or without Velcro
- 29" or 40" height
- Clips for attaching skirt to table, fifteen recommended for a 13'6" wide skirt
- Specify table thickness for correct clips (1" to 2½")

CALL FOR PRICING

TABLE TOP VINYL

- Available in 75lb rolls
- Flame Resistant
- 4mm thickness

CALL FOR PRICING



SINGLE BOOTH

BASIC BOOTH PACKAGE INCLUDES:

- One 8' high back wall (usually 8' to 10' wide and requires four drape panels, each 48" wide)
- Two 3' side walls (requires six drape panels at 3' high by 3' wide or one drape panel at 3' high by 12' wide)
- We offer standard trade show drape in the full range of Banjo cloth colors

Part #	Price
SD-DKBOOTH	\$270.00

Call for volume pricing and other discounts!

On a tight budget?

We also rent complete trade show booths. Call for a quote.

CREATE A UNIQUE TRADE SHOW WITH CUSTOM DRAPE!

- Custom drape at reasonable prices
- Create the trade show of your dreams using muslin, satin or sheer
- Priced per your specifications

CALL FOR PRICING

ASK ABOUT FINANCING!



STARTER BOOTH PACKAGES

PACKAGE 1:

Makes 24 in-line booths with an 8' high back wall and 3' high side walls.

PACKAGE 2:

Makes 24 back-to-back booths with an 8' high back wall and 3' high side walls.

PACKAGE 3:

A combination of packages 1 and 2 and makes 12 in-line and 10 back-to-back booths with an 8' high back wall and 3' high side walls.

PARTY PACKAGES

PACKAGE 1:

Makes 9 single area partitions, 16 in-line partitions with 8' high sides or 22 back-to-back area partitions. Comes with 6'-10' crossbars.

PACKAGE 2:

Makes 9 single area partitions, 16 in-line partitions with 8' high sides or 22 back-to-back area partitions. Comes with 7'-12' crossbars.

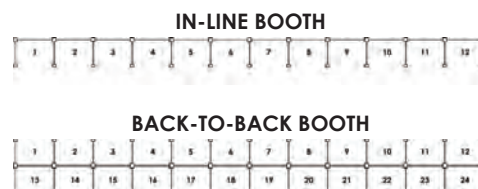

CALL FOR PRICING

100' DRAPE PACKAGE

- Discount package price for a complete pipe and drape system
- Includes all necessary hardware, drape (to hang at 50% fullness), cases and hampers
- Allows for multiple configurations

Part #: S-DK100PACK

100' AT 16' HIGH - 14oz KING IFR DRAPE WITH HARDWARE & STORAGE

Qty	Description	List Price Ea.	Total
13	9'-16' adjustable upright	\$79.15	\$1,028.95
13	18" x 18" x 3/8" 35lb base with 8" pin	\$65.00	\$1,027.00
13	25lb sandbags	\$35.00	\$455.00
11	7'-12' horizontal drape supports	\$32.88	\$361.68
11	Drape (each 16' high x 13' wide) (sewn flat)	\$394.86	\$4,343.46
2	Pipe cases (fits all uprights and horizontals)	\$395.00	\$790.00
2	16 bushel molded plastic hampers	\$349.00	\$698.00
2	Heavy-duty baseplate storage box	\$259.00	\$518.00
1	Hand truck	\$139.00	\$139.00

(10% Discount) ~~\$9,361.09~~ **Package Price: \$8,424.98**

Part #: S-DKSURR

ADDING SCREEN SURROUND DRAPE AND SKIRT CLAMPS

Qty	Description	List Price Ea.	Total
2	Skirt clamps	\$19.95	\$39.90
4	Drape legs at 16' h x 4' w	\$151.01	\$604.04
1	Header at 1' h x 13' w	\$99.28	\$99.28
1	Header at 1' h x 9' w	\$73.06	\$73.06
1	Header at 1' h x 4' w	\$49.56	\$49.56
1	Skirt at 5' h x 13' w	\$177.75	\$177.75
1	Skirt at 5' h x 9' w	\$126.22	\$126.22
1	Skirt at 5' h x 4' w	\$78.96	\$78.96
2	16' pole socks	\$32.00	\$32.00

(10% Discount) ~~\$1,280.77~~ **Package Price: \$1,152.69**

Note: All dimensions and weights are nominal.

HOW TO ORDER:

Please call, fax, or email (sales@drapekings.com) for an estimate. If you're not sure of the details, just tell us the color, height, and length of the drape and we will price your order to include the optimal fullness and all the necessary support hardware. Most hardware items are in stock and can ship same day if ordered by 2pm.

CUSTOM ORDERS:

Please allow extra time, including shipping, to ensure that your custom order is completed and arrives to you on time. Some items in our catalog are made to order and are not immediately available. Custom orders require from 50 - 100% non-refundable credit card deposit.

PRICES:

We reserve the right to change prices and/or discontinue items without notice.

PAYMENT:

We accept Visa, Mastercard, Discover and American Express.



Company checks will be accepted with approval or prepayment. Returned company checks will incur a \$35 bank and processing fee.

SHIPPING:

Prices exclude freight charges and are shipped FOB from our facility in North Bergen, N.J. Please specify your carrier of choice when ordering. All prepaid freight charges will be added to your invoice. If requested, we will be happy choose the best carrier suited to your needs but we cannot be held responsible for the shipper's performance be it your choice or ours. Standard insurance charges will be included for replacement values. Customer MUST inspect shipment and establish any damage claims immediately at drapekings.com/claims.

RETURNS:

Cancellations or returns must be authorized in advance. In order to return an item, you must first request an RMA (Return Merchandise Authorization) number. Drape Kings must receive this request no later than seven (7) business days from receipt of the merchandise. You may request an RMA number by calling our sales department.

NO returns will be accepted on cut merchandise, special orders, or custom fabrication. If the order has shipped, it will be subject to shipping and restocking charges as described above. Returned Items must not have been used and must be returned with all original packaging. All sales are considered final 30 days after purchase.

SALES TAX RULES:

All sales in California, Florida, Illinois, Maryland, Nevada, New York, New Jersey, Virginia, and Washington D.C. will be charged sales tax. Resale or exempt certificates must be provided to us prior to shipment of goods to avoid tax charges. Use tax may apply; check with your accountant or tax authority. If you choose to pick up the goods from our facility, you will be charged sales tax unless you have a New Jersey resale/exempt certificate.

RENTALS:

Most items in the catalog are also available to rent. Please inquire with our rental department for pricing (rentals@drapekings.com).

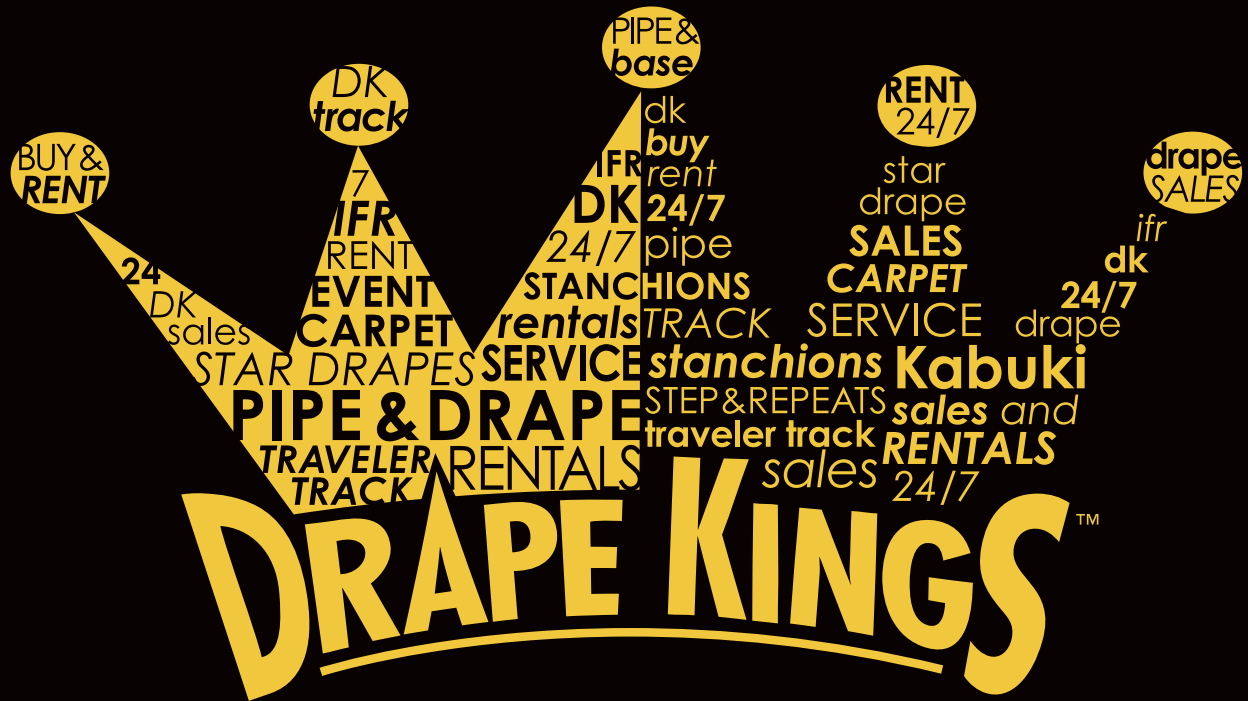

NEW YORK

3200 Liberty Avenue • 2C
North Bergen, NJ 07047

201.770.9950 📞

WASHINGTON, D.C.

5114 Roanoke Place
College Park, MD 20740

301.220.0001 📞

CHICAGO

2048 W. Carroll Avenue
Chicago, IL 60612

312.733.7660 📞